

Reference Manual

R FR 5014

Series 5000 2RU 19" Rack Frame

R FR 5012

Series 5000 2RU 19" Rack Frame with Fan Front Cover

Revision 2.1 – September 2011

Information in this document is subject to change without notice. No part of this document may be reproduced or transmitted in any form or by any means, electronic or mechanical for any purpose, without express written permission of LYNX Technik AG.

LYNX Technik AG may have patents, patent applications, trademarks, copyrights or other intellectual property rights covering the subject matter in this document. Except as expressly written by LYNX Technik AG, the furnishing of this document does not give you any license to patents, trademarks, copyrights or other intellectual property of LYNX Technik AG or any of its affiliates.

LYNX Technik AG
Brunnenweg 3
D 64331 Weiterstadt
Germany
www.lynx-technik.com

Contents

Contents	2
Warranty	4
Regulatory information	5
Europe.....	5
Declaration of Conformity	5
USA	5
FCC 47 Part 15.....	5
SAFETY WARNING	6
SICHERHEITS WARNUNG!.....	7
Getting Started.....	9
Packaging	9
Product Description	9
Power Supply	10
Rear Termination Panel	11
Rack Connections	11
Power Connection.....	11
Alarm Connection	12
Alarm Function.....	12
Extend Connection.....	13
Control Connection	13
LAN Connection.....	14
External Sync Connection.....	14
Alarm/LED Status Indicators.....	15
Power Supply LED Indicators	15
Fan Alarm LED	15
Rack Configuration	16
Assembly	16
Rack Layout Considerations	16
Rear Connection Plates.....	16
Redundant Power Supply	16
Remote Controller.....	16
Hot Swapping	17
Power Supplies	17
Power Supply Failure.....	17
CardModules	17
Air Flow /(R FR 5012).....	18
Air Flow /(R FR 5014).....	19

Rack Installation 20

 Location **20**

 Ventilation..... **20**

 Mechanical Installation..... **20**

Electrical Installation. 20

Front Cover Removal..... 21

Compatibility with R FR 5010 and R FR 5011 23

Installation Instructions..... 23

Installations-Anweisung 24

Specifications 25

Service 26

 Parts List **26**

 Technical Support **26**

Contact Information 26

Warranty

LYNX Technik AG warrants that the product will be free from defects in materials and workmanship for a period of three (3) years from the date of shipment. If this product proves defective during the warranty period, LYNX Technik AG at its option will either repair the defective product without charge for parts and labor, or will provide a replacement in exchange for the defective product.

In order to obtain service under this warranty, customer must notify LYNX Technik of the defect before expiration of the warranty period and make suitable arrangements for the performance of service. Customer shall be responsible for packaging and shipping the defective product to the service center designated by LYNX Technik, with shipping charges prepaid. LYNX Technik shall pay for the return of the product to the customer if the shipment is within the country which the LYNX Technik service center is located. Customer shall be responsible for payment of all shipping charges, duties, taxes and any other charges for products returned to any other locations.

This warranty shall not apply to any defect, failure, or damage caused by improper use or improper or inadequate maintenance and care. LYNX Technik shall not be obligated to furnish service under this warranty a) to repair damage resulting from attempts by personnel other than LYNX Technik representatives to install, repair or service the product; b) to repair damage resulting from improper use or connection to incompatible equipment; c) to repair any damage or malfunction caused by the use of non LYNX Technik supplies; or d) to service a product which has been modified or integrated with other products when the effect of such modification or integration increases the time or difficulty servicing the product.

THIS WARRANTY IS GIVEN BY LYNX TECHNIK WITH RESPECT TO THIS PRODUCT IN LIEU OF ANY OTHER WARRANTIES, EXPRESS OR IMPLIED. LYNX TECHNIK AND ITS VENDORS DISCLAIM ANY IMPLIED WARRANTIES OF MERCHANTABILITY OR FITNESS FOR A PARTICULAR PURPOSE. LYNX TECHNIK'S RESPONSIBILITY TO REPAIR AND REPLACE DEFECTIVE PRODUCTS IS THE SOLE AND EXCLUSIVE REMEDY PROVIDED TO THE CUSTOMER FOR BREACH OF THIS WARRANTY. LYNX TECHNIK AND ITS VENDORS WILL NOT BE LIABLE FOR ANY INDIRECT, SPECIAL, INCIDENTAL, OR CONSEQUENTIAL DAMAGES IRRESPECTIVE OF WHETHER LYNX TECHNIK OR THE VENDOR HAS ADVANCE NOTICE OF THE POSSIBILITY OF SUCH DAMAGES.

Regulatory information

Europe

Declaration of Conformity

We	LYNX Technik AG Brunnenweg 3 D-64331 Weiterstadt Germany
<i>Declare under our sole responsibility that the product</i>	
TYPE: R FR 5012; R FR 5014	
<i>To which this declaration relates is in conformity with the following standards (environments E1-E3):</i>	
EN 55103-1 /1996	
EN 55103-2 /1996	
EN 60950-1 /2006	
<i>Following the provisions of 89/336/EEC and 73/23/EEC directives.</i>	
	Winfried Deckelmann
Weiterstadt, May 2010	
<i>Place and date of issue</i>	<i>Legal Signature</i>

USA

FCC 47 Part 15

This device complies with part 15 of the FCC Rules. Operation is subject to the following two conditions: (1) This device may not cause harmful interference, and (2) this device must accept any interference received, including interference that may cause undesired operation.

Note: This equipment has been tested and found to comply with the limits for a Class A digital device, pursuant to the part 15 of the FCC Rules. These limits are designed to provide reasonable protection against harmful interference when the equipment is operated in a commercial environment. This equipment generates, uses, and can radiate radio frequency energy and, if not installed and used in accordance with the instruction manual, may cause harmful interference to radio communications. Operation of this equipment in a residential area is likely to cause harmful interference in which case the user will be required to correct the interference at his own expense.

SAFETY WARNING

Electrical supplies in excess of 50 (fifty) volts peak value are potentially hazardous or lethal. AC supplies between 100 and 250 peak volts exist within the rack frame chassis when connected to AC power.

Only qualified personnel should service the rack frame assembly.

Removal of technical earth may render the equipment dangerous and intentional removal is prohibited.

This unit has to be separated from mains by disconnecting the power supply cords.

This unit may have two power supplies and two power supply cords. Disconnect all power supply cords before servicing to avoid electric shock.

The power cords must meet the safety requirements of the country where the rack frame is used and has to be approved in this country.

DOUBLE POLE / NEUTRALE FUSING

After operation of the fuse, parts of equipment that remain energized might represent a hazard during servicing.

For continued protection against risk of fire, replace only with same type and rating of fuse.

F1 .. F4: T2AH250V

Replacement AC fuses must be of the specified type and rating: F1 .. F4: T2AH250V

The use of repaired fuses or shorting links has to be avoided.

Power Sockets for connection of the power cords to the unit have to be in close proximity to the rack frame and have to be accessible easily.

The unit has to be mounted in upright position (see instructions on page 20)

Ensure that all connections with information technology equipment comply with IEC 60950-1: 2005 / EN 60950-1: 2006.

WARNING! CAUTION!

SICHERHEITS WARNUNG!

Wenn das Gerät an das Wechselstromnetz angeschlossen ist, treten innerhalb des Gerätes Wechselspannungen zwischen 100 und 250 V auf, die potentiell gefährlich oder tödlich sein können. Deshalb darf eine Reparatur und Instandhaltung **nur von qualifiziertem Personal** durchgeführt werden.

Das Entfernen des Schutzleiters kann das Gerät in einen gefährlichen Zustand bringen, vorsätzliches Entfernen des Schutzleiters ist verboten.

Das Gerät ist durch Abziehen beider Netzstecker vom Netz zu trennen.

Das Gerät kann 2 Netzgeräte mit 2 Netzkabeln haben. Vor Servicearbeiten müssen alle Netzkabel abgezogen werden, um elektrischen Schlag zu vermeiden.

Die Netzzuführung ist 2-polig abgesichert. Nach Ausfall einer Sicherung können Teile der Schaltung weiter unter Spannung bleiben und bei Servicearbeiten zu Gefahren führen.

Vor Servicearbeiten Stromversorgung unterbrechen und Teile vor Berührung prüfen.

Nur Netzkabel benutzen, die für das Land, in dem der Träger benutzt wird, zugelassen sind.

Um Schutz gegen Feuer aufrechtzuerhalten, sind bei Sicherungswechsel nur Sicherungen des gleichen Typs mit gleichen Daten zulässig.

F1 .. F4: T2AH250V

Steckdosen für den Anschluss der Netzkabel müssen sich in unmittelbarer Nähe des Gerätes befinden und müssen frei zugänglich sein.

Das Gerät darf nur bestimmungsgemäß, d.h. mit der Geräteoberseite nach oben installiert werden (siehe auch Hinweise auf Seite 20).

Es muss sichergestellt sein, dass alle Verbindungen mit anderen Geräten der Informationstechnologie der Norm IEC 60950-1: 2005 / EN 60950-1: 2006 entsprechen.

WARNUNG!

ESD Warning



The internal electronics parts of this product are static sensitive. Please use caution and use preventative measures to prevent static discharge or damage could result to modules.

Electrostatic discharge (ESD) damage occurs when electronic assemblies or the components are improperly handled and can result in complete or intermittent failure.

Do not handle the module unless using an ESD-preventative wrist strap and ensure that it makes good skin contact. Connect the strap to any solid grounding source such as any exposed metal on the rack chassis or any other unpainted metal surface.

Caution

Periodically check the resistance value of the antistatic strap. The measurement should be between 1 and 10 Megohms.

Getting Started

Packaging

The shipping carton and packaging materials provide protection for the rack frame during transit. Please retain the shipping cartons in case subsequent shipping of the product becomes necessary.

Product Description

The R FR 5012 and R FR 5014 is a high quality 2 RU high 19 inch rack frame enclosure for the LYNX Series 5000 CardModules, designed primarily for broadcast and professional applications.

The rack frame can accept up to 10 Series 5000 CardModules plus an optional controller card. All modules are installed from the front. Module connection plates are supplied with each CardModule and are mounted on the rear of the rack to align CardModules installed. All CardModules and power supplies are hot swappable.

NOTE: Picture shows R FR 5012. The R FR 5014 has no fans in the front cover mounted.



The R FR 5012 and R FR 5014 features connections for remote alarming, serial control and a local extension port. A LAN connection is also provided for use with the optional R CT 5031 Master Controller.

Optional redundant power capability can be installed and two separate AC power connections are provided for maximum isolation. The power supplies have sophisticated power filtering with microprocessor control for power and temperature monitoring and communication with the control system. An on board multifunction LED has various states to indicate different alarm conditions and a separate GPO alarm output is provided for connection to an external monitoring system.

The R FR 5012 rack frame has a front cover with integrated fans for applications where no external forced cooling is available or if modules with high power dissipation are used in this rack frame.

All electrical contacts inside the RFR 5012 and R FR 5014, CardModules and power supplies are gold plated ensuring maximum reliability and protection from corrosion.

The R FR 5012 / 5014 is the primary building block in the LYNX Series 5000 CardModule system that provides high quality, modularity and flexibility in a very small form factor.

Power Supply

The R FR 5012 / 5014 includes the primary power supply. A second identical power supply can be added for redundancy. The Power supply is a sophisticated design designed for critical applications and includes power filtering and integral microprocessor. This monitors the supply operation and reports into the control system. Should a fault develop, the errors are alarmed in the following ways:

- Via the LED located on the front of the supply (see below).
- Via a GPO alarm via the alarm connector on the termination panel, if a controller option is fitted
- Via the control system (if installed)

If the redundant power supply R PS 5012 is installed, the system will switch supplies automatically in the event of primary supply failure, with no interruption to the normal operation of the system.

The supply has a noiseless integral DC fan for cooling.

The supply is installed and removed from the front of the rack. The supply locks itself firmly in place. The power supply can be released by pushing up the locking clip (see below)

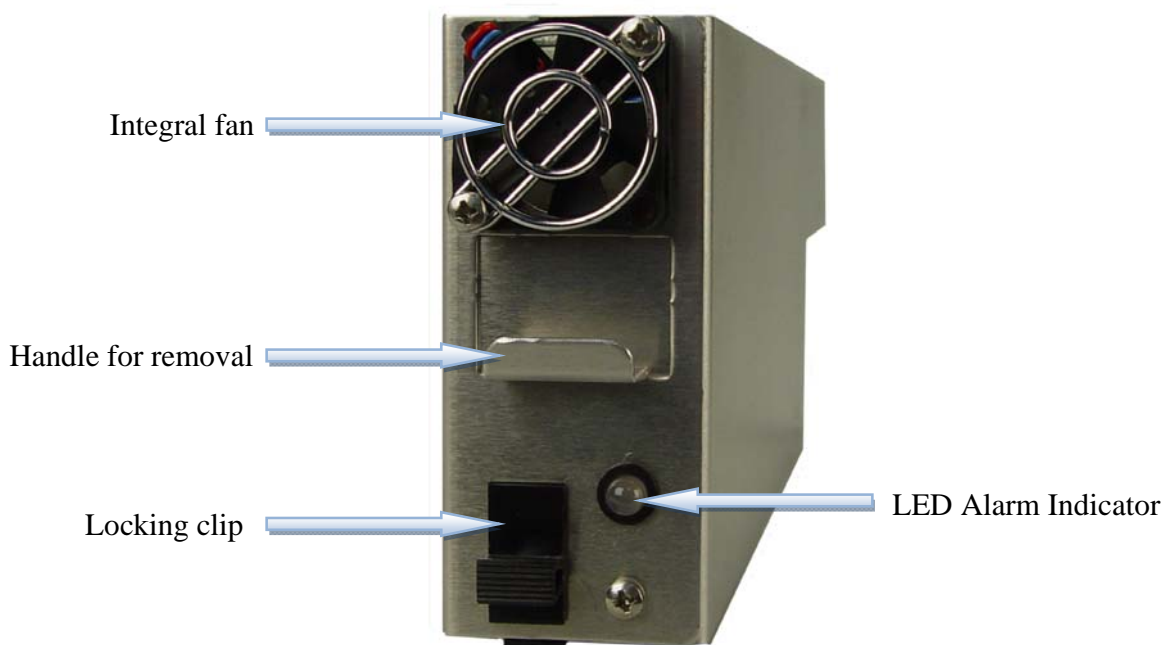

Power Supply seen from the front

Rear Termination Panel

The R FR 5012 / 5014 has an integral termination panel on the rear of the rack for the connection of power and various other connections for expansion and interfacing.

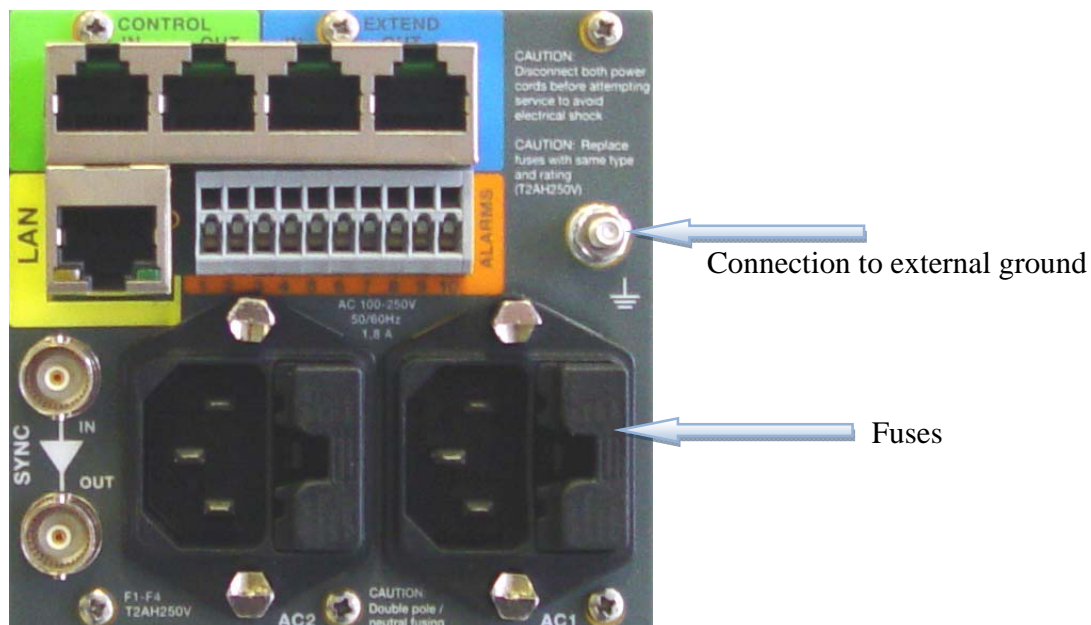

Rack

Connections

Power Connection

There are two power connections provided for the rack. One is for primary power and the second for the optional redundant power supply. Input power range is 100 to 240VAC 50 to 60Hz. Connection is made using an IEC power cable. For systems without redundant power connection is made to **AC1** in only. The power fuses are in the connector assembly and removal of this small module will enable fuse exchange. Please ensure you use the correct fuse rating. (2A). (2 fuses required, double pole neutral fusing is implemented)

A stud is provided on the termination panel for the connection of an external ground

Note: the chassis is permanently grounded via the AC connections



Caution

Service to be performed by qualified personnel only



Caution

Please remove power before attempting to exchange a power fuse. Only replace the fuse with a correctly rated replacement. For safety **DO NOT** physically disconnect or isolate the rack from earth for any reason.

Alarm Connection

An external alarm connection is available from the rack.

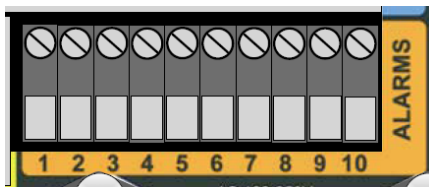

1	2	3	4	5	6	7	8	9	10
GPI B	GPI A	Alarm 4B	Alarm 4A	Alarm 3B	Alarm 3A	Alarm Minor B	Alarm Minor A	Alarm Major B	Alarm Major A

Function and connection information is described below.

Alarm Function

This function requires the controller option. The user can assign triggers for the preferred Major / Minor and No Alarm conditions using the controller and supplied software (see below in the GUI section).

The alarm connector provides GPO contacts for 2 alarm levels and two more Alarms and a GPI input for future use. This allows for the connection of an external monitoring system. Alarm conditions are triggered by the optional control system and will vary depending on the configuration of the system and user preferences.

For critical failures in the rack a contact can be closed between **Alarm Minor A** and **Alarm Minor B**.

Two examples of “critical” type failures are listed below*:

- Over temperature
- Redundant Power Supply Failure

For major failures in the rack a contact can be closed between **Alarm Major A** and **Alarm Major B**. One example of a “major” failure in the rack is:

- Loss of Power

Extend Connection

Bus Extension. This connection is used to interface racks together when using the optional LYNX control system. This is a simple (and inexpensive) way to extend the reach of the host RCT 5021 or R CT 5031 controller into several more racks fitted with RCT 5010 bus expanders. It uses a **proprietary** LYNX control interface and this connection has an input port as well as an output port for simple control configuration of all connected racks.

The connection is a standard RJ45 female connector.

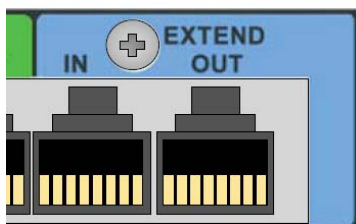

Pin 8 ... 1

Standard networks cables (we recommend the use of shielded cables) can be used to connect the racks. On each rack frame an input and an output port for the extend bus is provided.

Pin Number	Connection	Pin Number	Connection
1	SPI CLK A (Prop CLK A)	6	SPI MISO B (Prop RX B)
2	SPI CLK B (Prop CLK B)	7	SPIX SEL1 (Prop SEL 1)
3	SPI MISO A (Prop RX A)	8	SPOIX SEL2 (Prop SEL 2)
4	SPI MOSI A (Prop TX A)		
5	SPI MOSI B (Prop TX B)		

Note. When using this interface all connected racks must be mounted relatively close together, as the distance of this interface is restricted to approx. 10m for the total chain over all connected rack frames. Please refer to the R CT 5010 Rack Bus Expander reference manual for more details on this interface.

Control Connection

An external Control Interface is provided on the rear termination panel. When an RCT 5021 Rack Controller (or RCT 5031 Master Controller) is fitted to the rack this port can be used for two primary functions:

1. When configured as a RS 232 serial port this can be connected directly to a PC running the LYNX Desktop Controller application.
2. When configured for RS 422/485 operation this port is used to connect a rack frame with an RCT 5031 master controller connected to other racks fitted with RCT 5021 Rack controllers (up to 15 additional racks) using the IN and OUT connections provided.

Note. Please refer to the R CT 5021 Reference Manual for details on how to re-configure the port and more detail on the use of this control interface.

The connection is a standard RJ45 female connector.

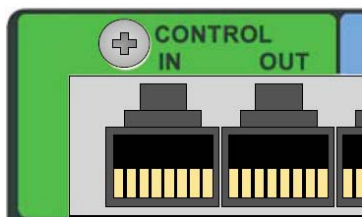

Standard networks cables (we recommend the use of shielded cables) can be used to connect the racks. On each rack frame an input and an output port for the control bus is provided.

Pin 8 ... 1

Connections for RS 422

Pin Number	Connection	Pin Number	Connection
1	GND	6	SER RX B
2	GND	7	n.c.
3	SER RX A	8	n.c.
4	SER TX A		
5	SER TX B		

Connections for RS 232

Pin Number	Connection	Pin Number	Connection
1	GND	6	RX
2	GND	7	n.c.
3	n.c.	8	n.c.
4	TX		
5	n.c.		

LAN Connection

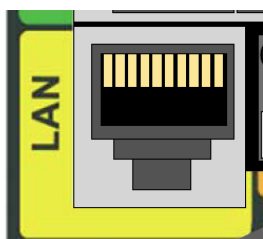

This is a standard RJ45 connection and is used to provide standard TCP/IP network control connectivity into a control system. To be operational this port requires the RCT 5031 Master Controller to be fitted in the rack. Please see the reference manual of the RCT 5031 for more details on the use of this connection.

External Sync Connection

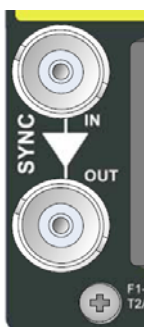

An external sync reference can be connected to the rack. An active loop through connection is provided with relay bypass in the event of a power failure.

The sync signal can be black / black burst or b-level composite analog NTSC or PAL sync or analog HDTV Tri-Level-Sync. This provides a single common reference to all module slots in the rack and can simplify the distribution of the reference signal in some installations. (Example connection of house sync)

Alarm/LED Status Indicators

There are a number of status / alarm indicators visible on the front panel of the R FR 5012 / 5014 Rack frame when closed.

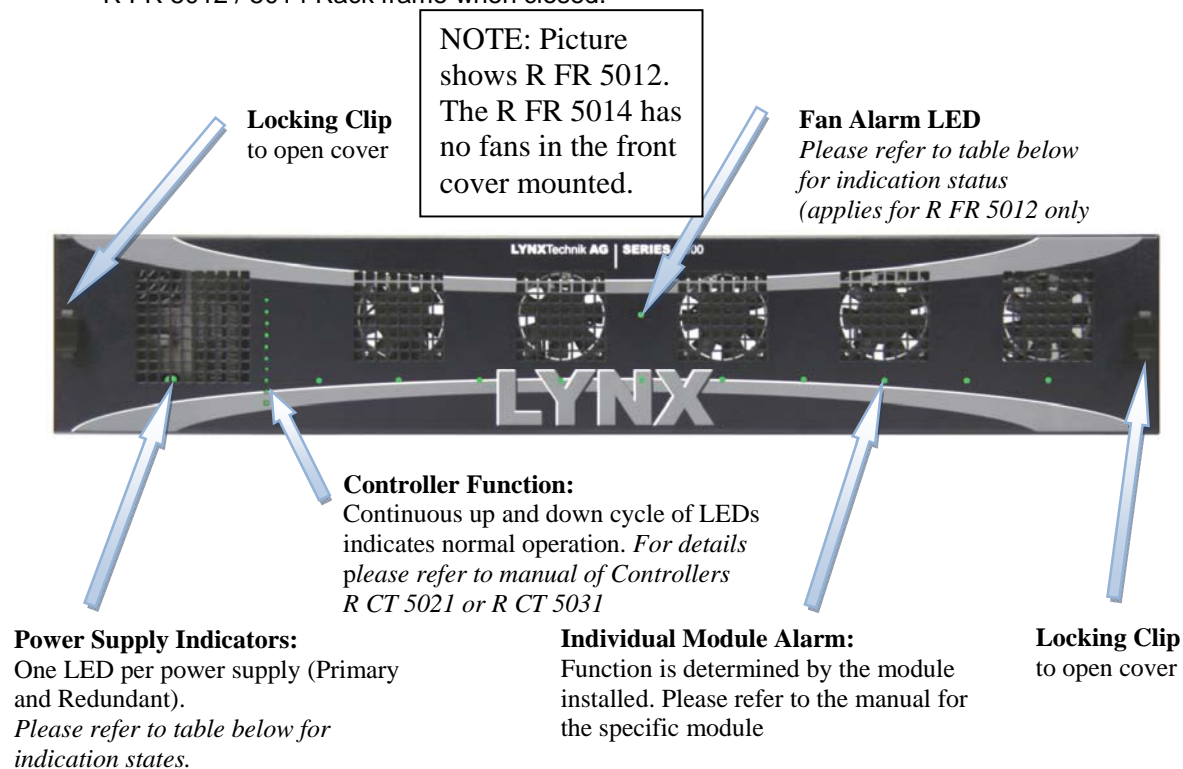

Power Supply LED Indicators

The Table below shows the error conditions for the LED on the power supply units. These are visible through the ventilation holes on the left side of the front of the rack

LED Color	Condition
Green	Normal Operation
Yellow	Warning: High Temperature
Red Flashing	Warning: Voltage out of range
Red Continuous	Warning: Over Temperature
Off	Failure: Exchange Supply

Fan Alarm LED

The Table below shows the error conditions for the LED on the fan front cover of the R FR 5012 / 5014. This is visible on the upper center of the front of the rack

LED Color	Condition
Green	Normal Operation, all fans working
Yellow	1 or more fans failed
Red Continuous	all fans failed

Rack Configuration

Assembly

If starting with an empty R FR 5012 / 5014 rack frame please follow the following steps for correct installation of the Series 5000 Card Modules

Rack Layout Considerations

If you have a variety of module types it's a good idea to plan the order in which you install the various CardModules. While a module can occupy any of the 10 available slots provided, consideration can be given to the position of the modules in the rack to facilitate external wiring. Below you can see an example layout.



Rear Connection Plates

The series 5000 CardModule is supplied with a connection plate and mounting screws. This is fitted to the rear of the rack frame behind the module.

Installing Rear Connection Plates

Position the connection plate on the rear mounting rails and secure with the screws provided. Do not fully tighten the screws initially. Test fit the module into the rack and make sure the edge connector on the module is aligned correctly with the connection plate. When alignment is correct, tighten the two screws. Remove and insert the module a few times to check installation. If the module binds or sticks, or installation is in anyway difficult then loosen the connection plate screws and check alignment. Repeat this process for each module.

Redundant Power Supply

The basic RFR 5012 / 5014 is supplied with the primary power supply installed. The redundant supply (option) is installed next to the primary supply.

Remote Controller

Depending on your system design you may have one of the LYNX controller options available (RCT 5010, RCT 5021 or RCT 5031). Install the controller into the first module slot next to the power supply(s). **This is an extra slot reserved only for the controller cards.** Please refer to documentation supplied with the controller for the configuration and use of the LYNX controller options.

Hot Swapping

Power Supplies

The Series 5000 CardModules and Power Supplies are fully hot swappable.

Power Supply Failure

A failure in the Primary power supply will automatically trigger the use of the redundant supply (if fitted) and will trigger the following alarm conditions / indications (requires controller option).

- Reported fault on the monitoring system
- Alarm GPO trigger on the alarm connector (see Alarm Connections section)
- Front Panel LED (normally green) will go out (See Alarm / Status indication section)

Once identified, the defective supply can be removed and replaced with power connected with no interruption to the operation of the CardModules, if the redundant supply is installed.

CardModules

If a CardModule fails the error will be reported over the monitoring system and via the front side alarm LED. Alarm function is module dependant so please refer to the CardModule manual for failure conditions and indications. The defective CardModule can be removed and replaced with an identical replacement without removing power from the frame.

NOTE: *If the "HOT SYNC" function is active in the installed controller, then the settings of the previous card will be automatically written back into the new modules flash ram once installed (if the same type). For further details on the "HOT SYNC" function please refer to the GUI sections of the R CT 5021 or R CT 5031 manuals*

Air Flow (R FR 5012)

Air flow is from the front (through the fans) to the back of the rack frame.

NOTE: Please make sure that the ventilation holes at the top and the rear edge are not covered.

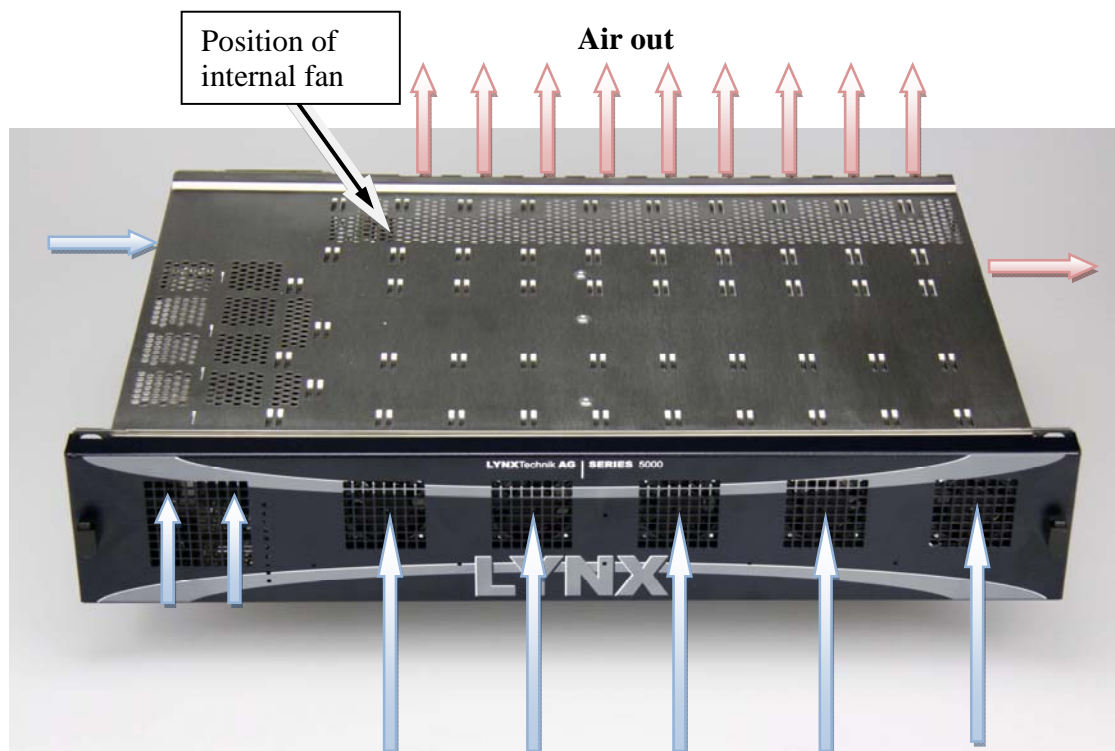

Cooled Air in

Additional ventilation holes are provided left and right of the rack frame to allow for some airflow if the front cover is open or removed. A fan in the back of the rack frame supports this additional airflow.

This additional fan can easily be replaced from the back of the rack frame. Remove the rear connection at the right and just pull the fan out and push in the replacement.

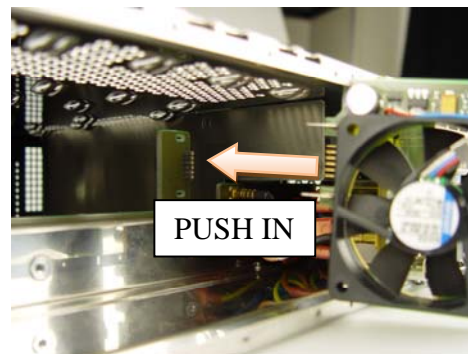
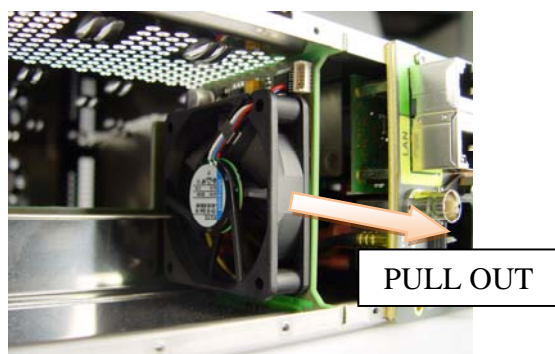

Air Flow (R FR 5014)

Air flow is from the bottom to the top of the rack frame.

NOTE: Please make sure that the ventilation holes at the top and bottom are not covered.

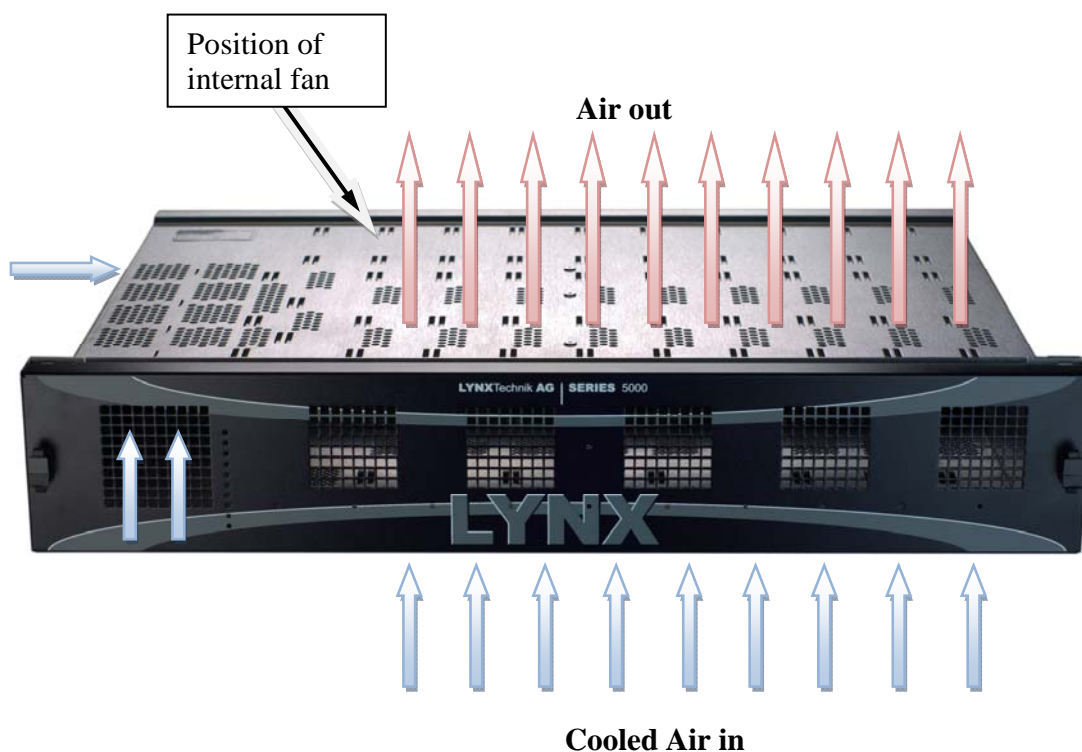

Additional ventilation holes are provided left and right of the rack frame to allow for some airflow if the front cover is open or removed. A fan in the back of the rack frame supports this additional airflow.

This additional fan can easily be replaced from the back of the rack frame. Remove the rear connection at the right and just pull the fan out and push in the replacement.

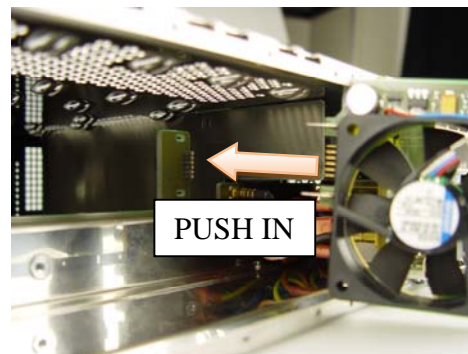
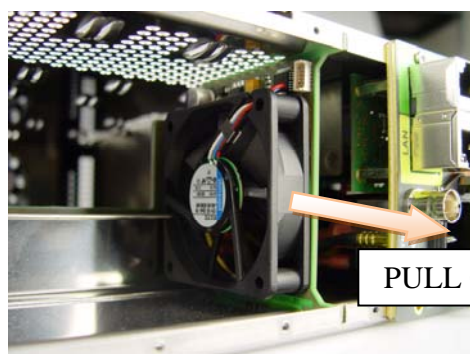

Rack Installation

If you have an empty R FR 5012 / 5014 rack frame we recommend you assemble the connection plates and modules as well as any options such as the redundant power supply and controller before mounting the Rack Frame into a 19" inch rack. (Please refer to assembly section)

Location

The R FR 5012 / R FR 5014 Rack frame can be located anywhere with 19-inch rack space available. The rack will take up 2 Rack Units (RU) of vertical rack space.

Ventilation

Depending on the installed modules we recommend not to stack more than three R FR 5012 / 5014 rack frames, with no space in-between. Allowance has been made in the design providing space between the racks for adequate air ventilation. Every third rack there should be 1 RU space should be provided for additional airflow.

Mechanical Installation

The R FR 5012 / 5014 is secured into a standard 19-inch rack using 4 standard rack screws. Remove front cover panel for installation, which allows access to the rack ears. Rear support of the rack using rack rails is recommended but not necessary.



Caution

The rack frame has to be installed in upright position as shown on the next page

Electrical Installation.

Electrical power is connected to the R FR 5012 / 5014 chassis via the two IEC power connectors located on the termination panel on the rear of the rack. There is no power switch provided. Two separate and isolated power connections are available, one for the primary power and one for the optional redundant power supply. Primary power is connected to **AC in 1**



Caution

Please remove power before attempting to exchange a power fuse. Only replace the fuse with a correctly rated replacement. For safety **DO NOT** physically disconnect or isolate the rack from earth for any reason.



Caution

Service to be performed by qualified personnel only

Front Cover Removal

The Front Cover with the integrated fans opens easily releasing the two locking clips. Push the locking clips from top and bottom and pull the front cover forward.

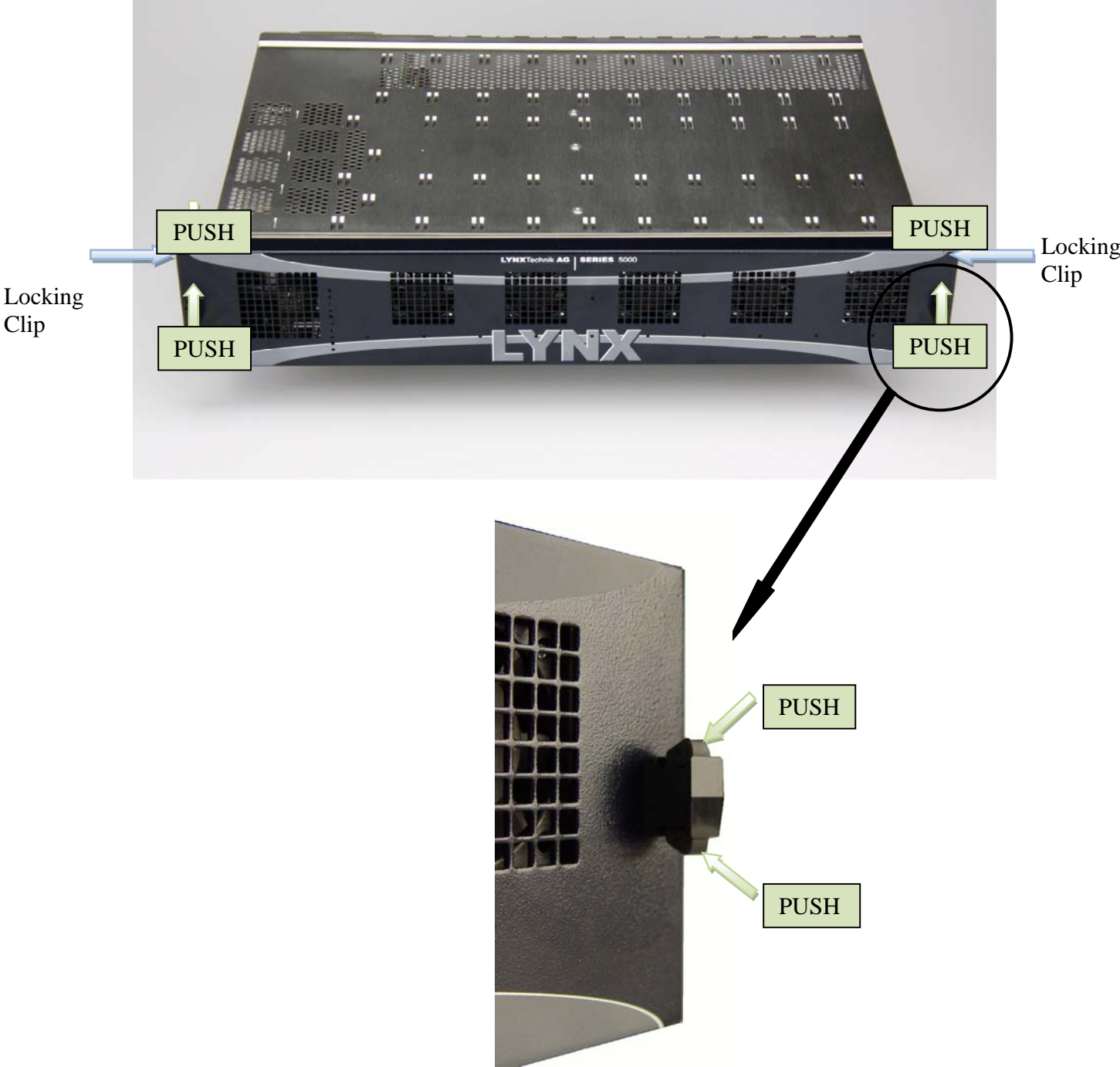

To remove the front cover, hold down the two metal bars left and right, which secure the hinges of the front cover.



Compatibility with R FR 5010 and R FR 5011

The R FR 5012 / 5014 is mechanically compatible with the older versions R FR 5010 and R FR 5011.

All Series 5000 card modules, controllers (R CT 5010, R CT 5020, R CT 5021, R CT 5030 and R CT 5031) and power supplies (R PS 5010 and R PS 5012) can be installed in all four rack frames.

To connect the EXTEND and/or ONTROL Bus (see above page 12/13, RJ45 connectors in the R FR 5012 / 5014) to the SubD9 connectors in the R FR 5010 and R FR 5011, LYNX provides an adapter from SubD9 male to RJ 45

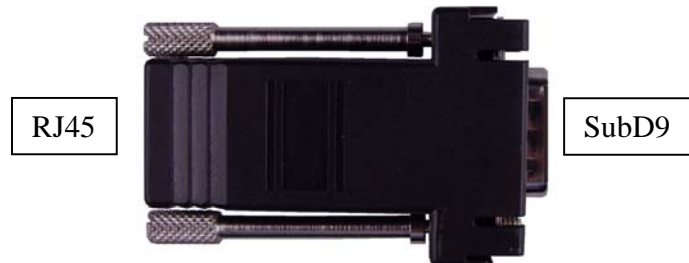

Installation Instructions

The rack frame chassis R FR 5012 / R FR 5014 is intended for operation in broadcast environments. The operation in excessive dust and moisture or extreme temperature requires special provisions like

- Dust filters
- Air conditioning
- Avoidance of condensed water



CAUTION!

The power cords must meet the safety requirements of the country where the rack frame is used and has to be approved in this country, e.g.

- CE-Mark in Europe
- UL-listed in USA
- CSA certified in Canada



CAUTION!

The power supply cords are used to disconnect the R FR 5010 / R FR 5011 from the mains supplies, make sure that the socket-outlets are located/installed near the equipment and are easily accessible.



CAUTION!

The rack frame chassis is a CLASS I EQUIPMENT, ensure before initial operation that protective earth is connected to the building wiring and zero potential is established.

The functional earth connection at the rear termination panel is connected internally to protective earth. If necessary, it may be used for potential equalization to other units.

Installations-Anweisung

Das Gerät R FR 5012 / 5014 ist für Anwendungen in Fernsehstudios vorgesehen. Der Einsatz in erhöhter staubiger und feuchter Umgebung oder außergewöhnlichen Temperaturen erfordert besondere Maßnahmen wie

- Klimatisierung
- Staubfilter
- Vermeiden von Kondenswasser.



ACHTUNG!

Die Netzkabel müssen den Sicherheits-Anforderungen in dem Land entsprechen in dem das Gerät verwendet werden soll und in dem Land zugelassen sein, z.B.

- CE-Zeichen in Europa
- UL-gelistet in USA
- CSA-Zulassung in Kanada



ACHTUNG!

Die Netzkabel dienen zur Trennung des Geräts vom Netz. Es ist sicherzustellen, dass die Steckdosen für den Netzanschluss in der Nähe des Gerätes angebracht und zum Trennen leicht zugänglich sind.



ACHTUNG!

Das Gerät ist nach der Schutzklasse I aufgebaut. Vor der ersten Inbetriebnahme muss sichergestellt werden, dass der Schutzleiter mit dem zentralen Schutzleiter des Gebäudes verbunden ist und spannungsfrei ist.

Der Erdanschlussbolzen an der Netzanschlussrückseite ist intern mit dem Schutzleiter verbunden. Falls erforderlich, kann er für den Potentialausgleich mit anderen Geräten verwendet werden.

Specifications

Mechanical	
Size	2 RU high x 325 mm deep including connectors and front cover. 31 cm without front cover. Standard 19" rack mount.
Weight (empty)	4,9 kg with single power supply
Connections	All connections made on rear of rack
Performance	
Available Card Slots	10 x CardModules (single width backplanes) 1 x Controller
	2 x Power Supplies (primary and optional redundant)
Power Indication (alarm)	One multifunction LED per supply and GPO output
	R FR 5012: Fan Alarm through front cover Module alarm LEDs visible through front cover
Controller alarm	LED bar
Connections (rear connections)	
LAN Connector	RJ 45 (10/100 Base T)
Control Connector	RJ 45 input and R J45 output
Extend Connector	RJ 45 input and R J45 output
Alarm Connector	Terminal strip Alarm Major and Minor: Relay contact closures
Ref In	BNC connection for rack reference, with active loop output
Primary AC	Standard IEC 60320 C13 AC power connector, double pole fused (2A)
Redundant AC	Standard IEC 60320 C13 AC power connector, double pole fused (2A)
Electrical Specifications	
Power Input	100 – 240VAC, 50Hz – 60Hz. Two separate and isolated connections for Primary and Redundant supplies.
Power Consumption	150W max.
Safety	IEC 60950-1:2005/ EN 60950-1:2006/VDE 0805-1
Ambient	
Temperature	5°C to 40°C Maintaining specifications 0°C to +50°C Operating
Humidity	Max 90% non-condensing
Altitude	up to 2000m
Supplied Accessories	
Documentation	Reference Manual CD

Service

Parts List

Due to the very dense design and high level of integration there the module is not user serviceable. Please contact LYNX for repairs or to request an exchange unit.

There is one consumable part used on this module which is the cooling fan. A service kit is available to exchange the fan. Ordering information below.

Technical Support

If you are experiencing problems, or have questions please contact your local distributor for further assistance.

Technical support is also available from our website.

Please do not return products to LYNX without an RMA. Please contact your authorized dealer or reseller for more details.

More detailed product information and product updates may be available on our web site:

www.lynx-technik.com

Contact Information

Please contact your local distributor; this is your local and fastest method for obtaining support and sales information.

LYNX Technik can be contacted directly using the information below.

Address LYNX Technik AG
Brunnenweg 3
D-64331 Weiterstadt
Germany

Website www.lynx-technik.com

E-Mail info@lynx-technik.com

LYNX Technik manufactures a complete range of high quality modular products for broadcast and Professional markets, please contact your local representative or visit our web site for more product information.

LYNXTechnik AG[®]

Broadcast Television Equipment